

Steelco VS L range

Small & Medium Laboratory Steam Sterilizers





Driven by customer needs

Steelco is a leading infection control solution provider, supplying the healthcare, laboratory research and pharma sectors. Active in over 100 countries, Steelco has equipped numerous world renown hospitals and counts among its customers household names in the laboratory, pharmaceutical and industrial sectors.

Driven by customer feedback, Steelco develops, manufactures and supplies solutions that maximize infection control safety and contamination prevention, optimize processes and minimize costs.

Our focus on innovation has led us to become leaders in areas such as automation, improving the efficiency and working environment of those that use Steelco products.

Whether you are just wishing to replace a single small machine or **requiring assistance in designing and equipping your scientific or research laboratory**, Steelco and it's factory trained dealers are here to help you make the best decision possible that works for you and then support you every step of the way.

R&D Department

Scientific Laboratories

Pharmaceutical Laboratories



Steelco's catalogues of the **washing systems for life sciences and laboratory applications:**

Washer disinfectors for **life science applications**



Laboratory glassware washer disinfectors



Steam sterilizing autoclaves

for pharma and research laboratories

Steelco is the ideal partner for the sterilization of glassware and other items used in laboratory activities or life sciences applications. Customers appreciate the **versatility, intuitive functionality, high performance** and **reliability** of the VS L Series. With an extensive range, models are available for any size facility.

Our experienced layout design team can help you plan your new or refurbished department and our process engineering team can develop cycles specifically to best meet your needs.



Supporting you every step of the way

Steelco provides technical service and user training courses at the Steelco Academy. Our optional remote diagnostics capabilities and worldwide team of factory trained engineers ensure that you receive the service support you need to cost effectively maximize the uptime of your sterilizers. Spare parts are readily available from Steelco logistic and technical support center.



Steelco's catalogues for the **pharmaceutical applications:**

Pharmaceutical **washing and sterilization** systems



Steelco VS L Series

Small and medium range for any size of facility

Steelco Steam Autoclaves are designed for sterilization of heat-resistant and moisture-stable materials such as metal parts, liquids in sealed or vented containers, porous loads, etc., used in scientific and research laboratories.

Steelco has developed a full range of high capacity steam sterilizers to provide the perfect solution from the smallest facility to the largest laboratory department. **Up to 8 standard chamber sizes with a volume from 110 to 920 litres**, are available with pressure vessel and relief valves that are PED and/or ASME marked or according to the directives of the country of destination.



VS L Small Range

*Automatic vertical sliding door
or manual hinged door*

Chamber volume

**from 110 litres (3 ⁸/₉ ft³)
to 675 litres (23 ⁵/₆ ft³)**

Standard compliant

Steelco manufactures according the ISO 9001 quality system. Steam sterilizers VS L series meet the following standards requirements:

- 2006/42/CE (Machinery Directive)
- 2014/30/EU (EMC Directive)
- 2014/68/UE (PED)

Additional technical norms and standards (according to country of destination and customer requirements):

- IEC 61010-2-040
- EN ISO 12100
- EN 61326
- EN 13445
- EN ISO 9712
- EN ISO 9606-1
- EN ISO 15614-1
- ASME code Sec.VIII div. 1 & div. 2
- UL compliant
- EN 285 (available upon request)

- **ECO water saving options**, unrivalled levels of efficiency.
- Single and double door pass through options.
- Manual hinged or automatic sliding door
- Technical service access either on the left or right loading side.



VS L Medium Range
*Automatic horizontal sliding door
or manual hinged door*

Chamber volume
from 600 litres ($21 \frac{1}{5} \text{ ft}^3$)
to 920 litres ($32 \frac{1}{2} \text{ ft}^3$)

Steelco VS LD Series



VS 13 LD - VS 9 LD
Vertical loading sterilizers
Hinged door

View pages 14-15.

Chamber volume
from 90 litres ($3 \frac{1}{6} \text{ ft}^3$)
to 125 litres ($4 \frac{2}{5} \text{ ft}^3$)

Steelco VS L range

Small and medium laboratory steam sterilizers

Flexible configuration

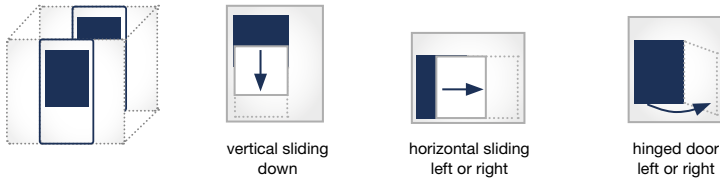

- *Single or double doors for pass through installation**
- *Sliding or hinged, automatic or manual doors**
- *Technical area either on the left or right side**

* *Limitation may apply based on country destination and sterilizer model/configuration*

Key features

- *AISI 316L stainless steel chamber with high efficiency heat transfer **full jacket system** for even heat distribution*
- *Doors internally made of stainless steel AISI 316L with no welding*
- *Heat insulation with durable reusable cover for fast service maintenance at a lower cost*
- *Load control probe included as standard*
- *Colour touch screen HMI with multi level user access system*
- *Built-in printer for process recording*
- *Non proprietary widely available durable spare parts*
- *ECO cool down water saving system included as standard*



User friendly colour touch screen.



Integrated printer and ethernet port.

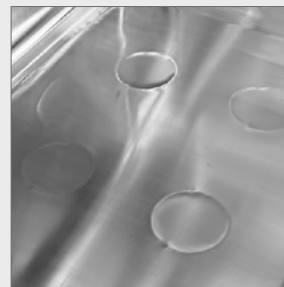

Full high efficiency heat transfer jacket system.



Piping made of AISI 316L stainless steel, available as option.

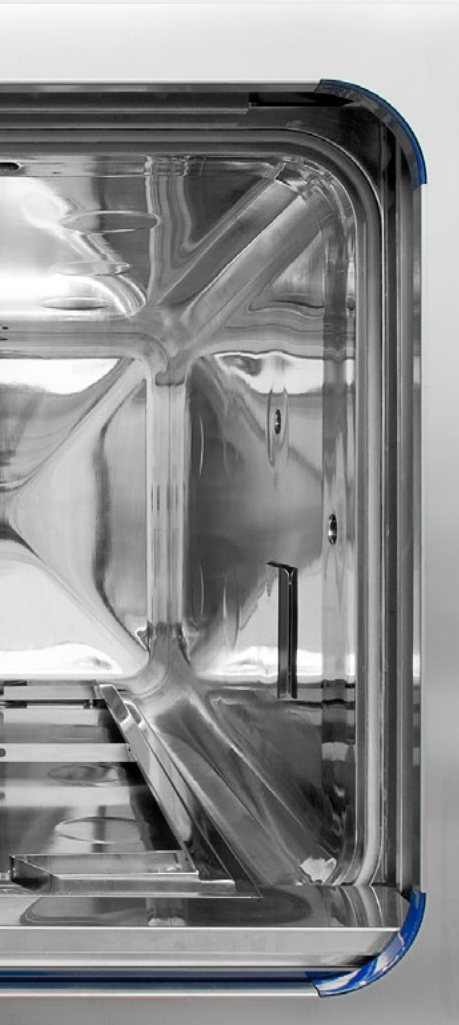

Air-differential seals
available as options

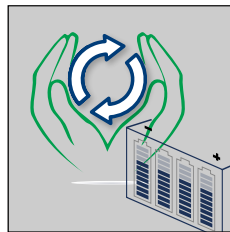

UPS option for up to 5
minutes of continuous
operation in the event of a
power failure.



Door internally made of stainless
steel AISI 316L with no welding.
Safe, hermetically sealing for
durability and reliability.

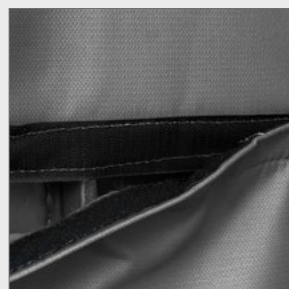

Heat insulation with durable
fabric covering for improved
service maintenance.



RTD (Resistance Temperature
Detectors) temperature probes.



High efficiency water ring
vacuum pump available as
option.



ECO water saving options

Unrivalled levels of efficiency

Steelco's sterilisers set new standards in utilities reduction.

Water saving options can reduce water consumption to nearly zero depending on chosen model and water saving configuration.

As part of its environmental water saving policy, Steelco equips **all sterilizers as standard** with its **ECO CD cool down system** water saving package.

Every drop counts!

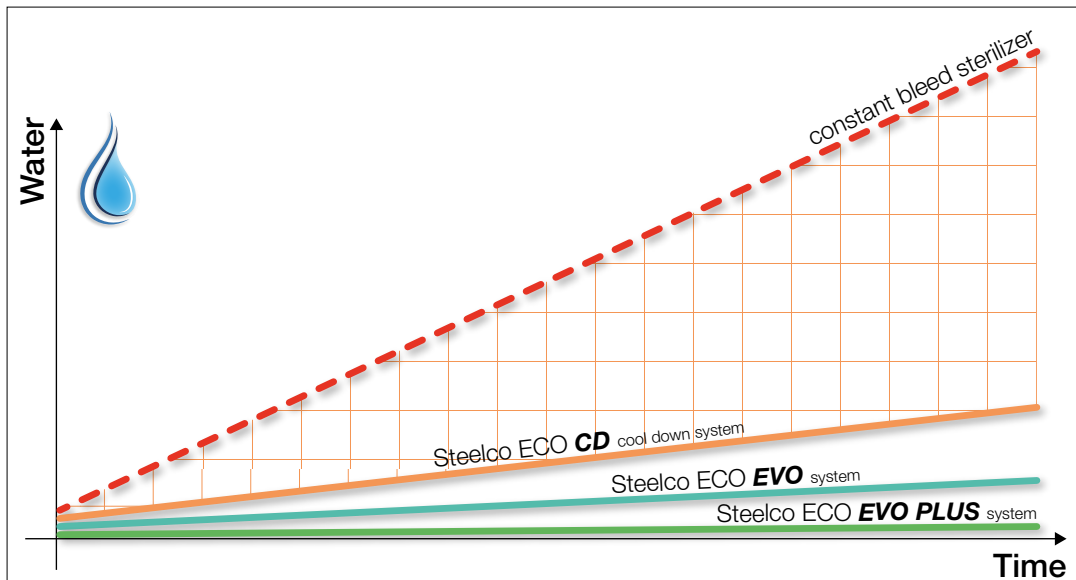

ECO configurations

CD cool down system

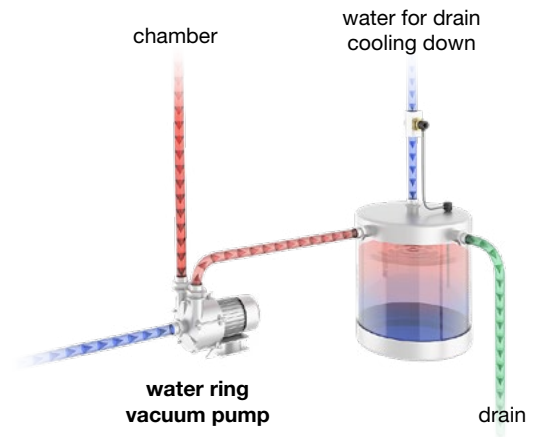
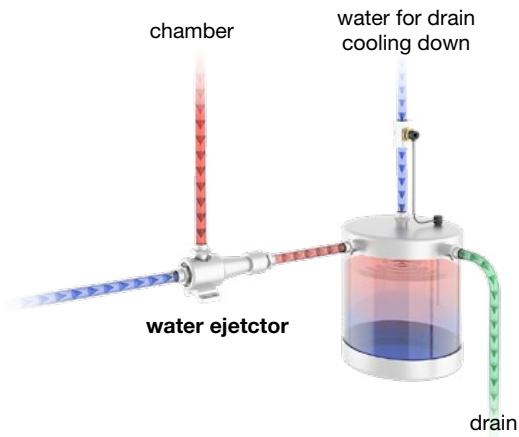

EVO system

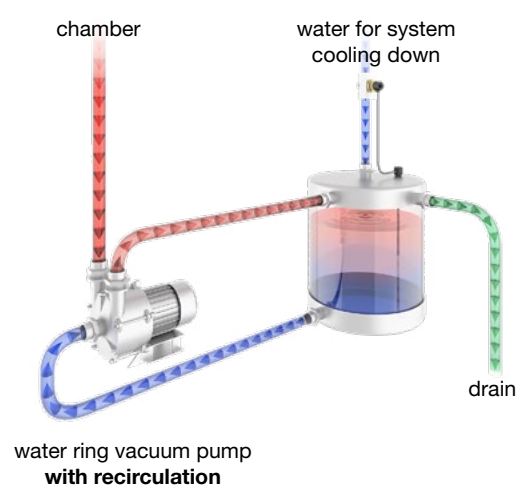
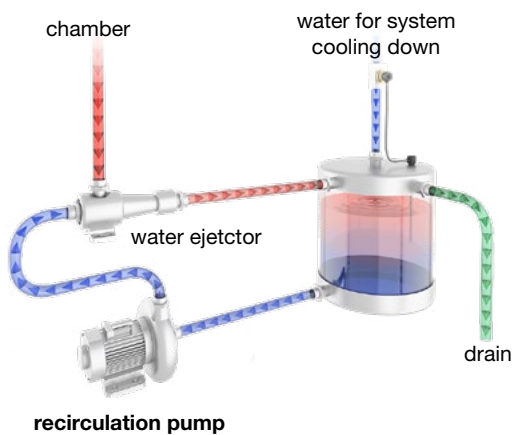

EVO PLUS system

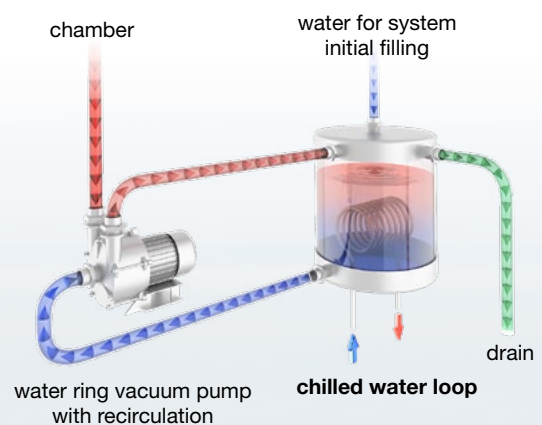
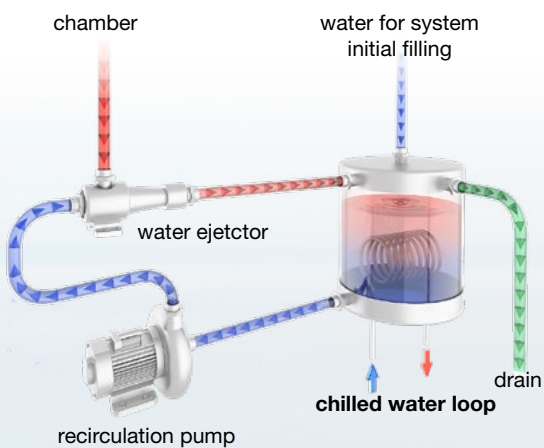



Machine configuration

Standard features

- Chamber made of AISI 316L stainless steel fine satin finishing $Ra < 2 \mu m$ ($Ra < 80 \mu inch$)
- Frame and external panels made of AISI 304 stainless steel
- Single door
- Steam form building
- Piping and valves in copper-brass
- Water ejector
- ECO CD - cool down system
- Solenoid valves or Pneumatic valves
- Load Control Probe
- Hinged front cabinet panel
- HMI - 7" touch screen display operating panel with PLC
- On board thermal printer on loading side
- Gravity Cycle
- Liquid Cycle
- Pre-Post Vacuum cycles
- Leak Test
- DART (Daily Air Removal Test) cycle
- Chamber rails
- Loading rack (not included)

Steam supply system

Standard steam supply:

- Steam from building

Optional steam supply:

- Integral electric steam boiler made of carbon steel or AISI 316L stainless steel
- Integral steam-to-steam AISI 316L boiler
- Combined functioning: building steam/electrical boiler made of carbon steel or AISI 316L stainless steel



Car and carriage

- Fixed height loading carriage and loading car with 2 or 3 shelves
- Perforated shelves in lieu of car and carriage system
- Individually customized loading car on request



Cycle configuration

To match your process needs

The following cycles are factory programmed and included as standard.

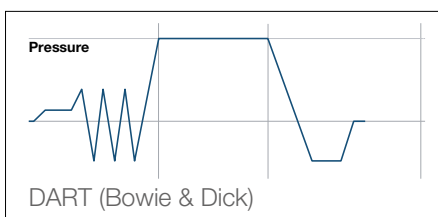
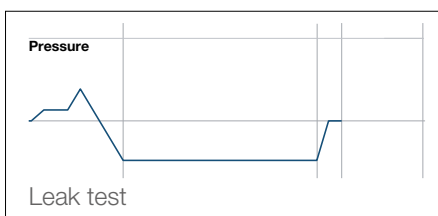
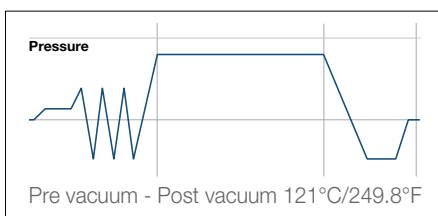
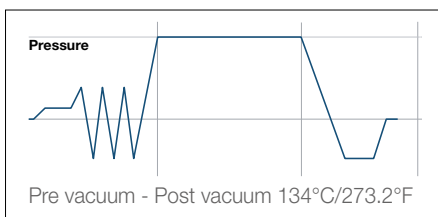
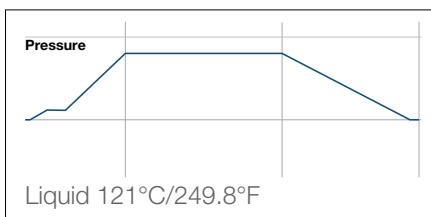
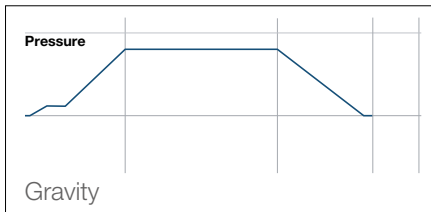

Jacket cooling, air over pressure with jacket cooling, effluent decontamination, low temperature cycle and F_0 function are available **as option**.

Steelco can develop and provide specific cycles to meet individual customers needs.



Machine configuration

Options

Structural machine configuration

- Second Door
- Chamber and doors polish finishing
- Chamber in 316TI stainless steel
- Air differential seal
- Side and top panels
- Floating switch for vessel
- Seismic Tie-Down Kit
- Seismic Calculations

Hydraulic configuration

- Vacuum Pump
- 316L Stainless steel process-steam wetted piping
- 316L Stainless steel valves and components
- Steam Filter for direct steam feeding
- On board 316L stainless steel Electric boiler
- On board Carbon Steel Electric boiler
- On board 316L Stainless steel Steam to Steam boiler for clean steam application
- Combined functioning: building Steam/Electrical boiler made of 316L Stainless steel or Carbon steel
- Boiler Automatic Blowdown
- Blow down tank for boiler
- Auxiliary Low Water Cutoff w/Manual Reset
- EVO cool down
- EVO PLUS cool down
- On board Air Compressor for valves and gasket only

Process cycle

- Jacket cooling with cold water
- Jacket cooling with water recirculation system
- Air Over Pressure with Jacket cooling
- Thermocouple fitting
- EN 285 - applicable requirements.
- Pipework for testing clean steam quality in compliance with EN 285
- Automatic air detector system - allowing also manual operation in compliance with EN 285.
- Manual air detector system - manual operation with check valves in compliance with EN 285.
- Degassing system for feeding boiler water
- Effluent Decontamination feature
- Additional filter for effluent decontamination feature
- Incinerator for effluent decontamination feature
- F0 function
- Low Temperature Cycle
- Water shower + counter pressure.
- H₂O₂ port

Control options

- HMI full capability on unload side
- Control panel on loading side SIEMENS IPC377E Family 15" TOUCH with PLC Siemens S7-1500 and developed with WinCC Advanced
- Audit Trail / User Management / Electronic Signature according 21 CFR 11
- SteelcoData View - cycle traceability software - 1 USB dongle - for the connection of up to 15 Steelco devices to one pc
- Connection for remote monitoring (tele-service)
- UPS - Uninterruptible power supply
- Volt free contact
- USB port

Further options

- Knocked down delivery

Accessories

- Additional fixed height loading carriage for unload side
- Perforated shelves in lieu of car and carriage system
- Load cart for floor loading
- Fixed height loading carriage
- Additional loading car with perforated shelves
- Additional perforated shelf for loading car
- Loading car minor customization

Documentation & Validation

- FAT Steelco standard Laboratory protocol and execution
- IQ-OQ protocols (onsite activities and lodge expenses not included)
- SAT Steelco standard Laboratory protocol (onsite activities and lodge expenses not included)
- Calibration certificates at factory's site
- 100% test I/O PLC at factory's site
- Temperature mapping test at factory's site

Note: Refer to Product technical specification (TS) for details.

Capacity and dimensions

The following tables show a selection of Steelco VS L standard models. In addition to the standard configurations, specific sizes can be made upon request. Refer to General Arrangement (GA) drawings for details and final connection point to utility services.

VS L - Small capacity range

All models are available **single or double door version**, except for VS 161626 L available in single door only.

Model	Door Opening	HMI position	Capacity	Chamber dimensions (mm/inch)			Overall dimensions (mm/inch)			
			Liters/ft ³	Width	Height	Depth	Width Sliding door	Width Hinged door	Height	Depth
VS 161626 L	Hinged or Sliding vertical	On top	110	406	406	660	635	870	1842	965
			4	16	16	26	25	34 1/4	72 1/2	38
VS 202038 L	Hinged or Sliding vertical	On top	250	508	508	965	737	972	1842	1270
			9	20	20	38	29	38 1/2	72 1/2	50
VS 262639 L	Hinged or Sliding vertical	On top	432	660	660	991	889	1125	1995	1296
			15	26	26	39	35	44 1/2	78 1/2	51
VS 262839 L	Sliding Vertical	On Side	462	670	700	986	1100	Not Available	1900	1292
			16 1/2	26	28	39	43 1/2		75	51
VS 262649 L	Hinged or Sliding Vertical	On top	542	660	660	1245	889	1125	1995	1550
			19	26	26	49	35	44 1/2	78 1/2	61
VS 262851 L	Sliding Vertical	On Side	603	670	700	1286	1100	Not Available	1900	1592
			21 1/2	26	28	51	43 1/2		75	62 1/2
VS 262661 L	Hinged or Sliding Vertical	On top	676	660	660	1549	889	1125	1995	1854
			24	26	26	61	35	44 1/2	78 1/2	73
VS 262861 L	Sliding Vertical	On Side	745	670	700	1586	1100	Not Available	1900	1892
			26 1/2	26	28	61	43 1/2		75	74 1/2

Note: Overall dimension depends on sterilizer model/configuration. Custom sizes also available.

VS L - Medium capacity range

All models are available in **manual hinged** or **automatic vertical sliding door**, **single or double** door version.

Model	HMI position	Capacity	Chamber dimensions (mm/inch)			Sliding Door Overall dimensions (mm/inch)			Hinged Door Overall dimensions (mm/inch)		
		Liters/ft ³	Width	Height	Depth	Width	Height	Depth	Width	Height	Depth
VS 263639 L	On Side	600	660	914	991	1860	1867	1272	1359	1867	1355
		21 1/2	26	36	39	73 1/4	73 1/2	50	53 1/2	73 1/2	53 1/3
VS 263649 L	On Side	750	660	914	1245	1860	1867	1525	1359	1867	1610
		26 1/2	26	36	49	73 1/4	73 1/2	60	53 1/2	73 1/2	63 2/5
VS 263660 L	On Side	920	660	914	1524	1860	1867	1805	1359	1867	1888
		32 1/2	26	36	60	73 1/4	73 1/2	71	53 1/2	73 1/2	74 1/4

Note: Overall dimension depends on sterilizer model/configuration. Custom sizes also available.

VS 13 LD - VS 9 LD

Vertical sterilizers

With proven and reliable high performance sterilizing technology, the new Steelco's vertical loading autoclaves meets the needs of a wide range of applications used in modern laboratories.

- + Safe, efficient and reliable performance
- + Unrivalled capacity/footprint ratio
- + Easy to use and modular loading
- + Equipment and cycle options for different applications



Main features

- Chamber and process piping made of stainless steel AISI 316L
- Single piece hinged door of stainless steel AISI 316L for durability and ease of cleaning. Full shockproof ABS cover. Easy and effortless door opening and closing
- Cladding made of stainless steel AISI 304
- Lockable antistatic castors
- Built-in electrical steam generator
- PT 1000 RTD flexible probe for liquid sterilization
- Easy service access and maintenance
- User friendly 7" touch screen panel HMI
- F₀ value calculation
- Cycle memory capacity of 660 cycles
- Service indicator
- Ethernet interface to traceability system

Cycle Programs

Standard working programs:

- Solids at 134°C/273,2°F
- Liquids at 121°C/249,8°F
- Glassware at 121°C/249,8°F
- Waste at 121°C/249,8°F

Test/service programs:

- Warm up to 121°C/249,8°F
- Maintaining temperature at 121°C/249,8°F

Additional programmes:

possibility to program up to 8 additional cycles



Free-standing, compact, vertical sterilizers:
cost-effective performance for laboratory
applications

Main options

Process performance options

- Vacuum pump for efficient pre vacuum air removal and post vacuum faster drying of **solid loads**
- Additional chamber heating with external steam coil to shorten cycles and enhance drying phase of **solid loads**
- Enhanced microbiologically filtered compressed air plus chamber cooling using cold water in an external coil for cutting in half the cool down time of **liquid loads**

Accessories

- Additional RTD flexible probe and data recording
- Additional pressure transducer and data recording

Connectivity and recording options

- Integrated thermal paper printer
- SteelcoData LAB supervisor software
- WiFi connection
- Barcode scanner



Loading accessories

- Lifting device with electronic control and swivel arm for fully assisted loading and unloading with easy handling at all load types.
- Several types and dimensions of loading baskets are available to optimize loading capacity.

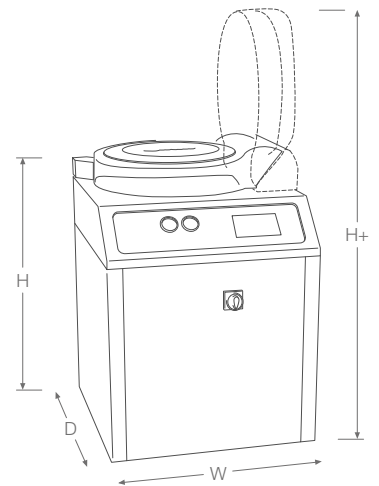

Dimensions

Model	chamber - mm / inch		litres / ft ³	overall - mm / inch			
	Ø	H		W	H	H+	D
VS 9 LD	420 / 16.53	636 / 25.04	90 / 3 1/6	720 / 28.35	1000 / 39.37	1467 / 57.76	723 / 28.46
VS 13 LD	420 / 16.53	896 / 35.28	125 / 4 2/5	720 / 28.35	1235 / 48.62	1702 / 67.01	723 / 28.46

Loading capacity (ml)



Erlenmeyer
flasks

model	250	500	1000	2000	3000
VS 9 LD	13 x 2	8 x 2	5 x 2	3 x 1	1 x 1
VS 13 LD	13 x 3	8 x 3	5 x 3	3 x 2	1 x 2



Flask bottles

model	250	500	1000	2000	3500
VS 9 LD	23 x 2	14 x 2	9 x 2	4 x 2	3 x 1
VS 13 LD	23 x 3	14 x 3	9 x 3	4 x 3	3 x 2



Miele Group Member

ARES - flexible endoscope automated reprocessing system



Dental washer disinfectors

Flusher disinfectors

Steam sterilizing autoclaves



Washer disinfectors for central of sterilization departments

Laboratory glassware washer disinfectors



Washing and sterilizing systems for life science and pharmaceutical applications

Headquarters

STEELCO S.p.A.

Via Balegante, 27 - 31039 Riese Pio X (TV) - ITALY
Ph. +39 0423 7561 - Fax +39 0423 755528
info@steelcogroup.com
www.steelcogroup.com

Branches

STEELCO ASIA

Puchong, Malaysia
info-asia@steelcogroup.com

STEELCO CHINA

Shanghai, China
info-cn@steelcogroup.com

STEELCO MEXICO

CDMX, Mexico
info-mx@steelcogroup.com

STEELCO SWITZERLAND

Spreitenbach, Switzerland
info-ch@steelcogroup.com

STEELCO AUSTRIA

Wals-Siezenheim, Austria
info-at@steelcogroup.com

STEELCO FRANCE

Paris, France
info-fr@steelcogroup.com

STEELCO NORDIC

Kgs. Lyngby, Denmark
info-nordic@steelcogroup.com

STEELCO USA

West Palm Beach, USA
info-usa@steelcogroup.com

STEELCO BELGIUM

Mollem, Belgium
info-be@steelcogroup.com

STEELCO GERMANY (DACH Area)

Gütersloh, Germany
info-de@steelcogroup.com

STEELCO NORGE

Nesbru, Norway
info-no@steelcogroup.com

STEELCO BENELUX

Vianen, Netherlands
info-benelux@steelcogroup.com

STEELCO HUNGARY

Budapest, Hungary
info-hu@steelcogroup.com

STEELCO SPAIN

Madrid, Spain
info-es@steelcogroup.com



Products offered for sale may differ from those described or illustrated in this brochure due to later production changes or/and optional configurations. The products and technical specifications are subjected to change without prior notice. Please consult your Steelco dealer for the latest information.

DC-PD-02-VS L USM EN Rev08